

Multicomponent Force Plate

Type 9286B...

Portable – for Applications in Biomechanics, F_z 0 ... 10 kN

Portable multicomponent force plate with aluminum top plate for measuring ground reaction forces, moments and the center of pressure in biomechanics.

- Excellent accuracy of center of pressure (COP)
- Very wide measuring range
- Easy mounting
- Flexible, mobile application
- Threshold $F_z < 250$ mN

Description

Rather than conventional frame mounted force plates, the multicomponent force plate Type 9286B... can simply be used on any flat surface. This drastically cuts installation costs. The plate's low overall height of just 35 mm and weight of under 18 kg allows flexible, portable use.

The piezoelectric 3-component force sensors have very low crosstalk values and in conjunction with the special design principle ensure excellent accuracy of the center of pressure.

Application

This force plate is designed specifically for use in gait and balance analyses. The Type 9286BA has a built-in charge amplifier compatible with all of the common motion analysis systems. Despite the very wide measuring range (0 ... 10 kN), this force plate offers excellent accuracy and linearity over the entire spectrum of applications (4 measuring ranges) and guarantees overload protection up to 12 kN.



Technical Data

Dimensions		mm	600x400x35
Measuring range	F_x, F_y	kN	-2,5 ... 2,5
	F_z	kN	0 ... 10
Overload	F_x, F_y	kN	-3/3
	F_z	kN	0/12
Linearity		%FSO	< \pm 0,2
Hysteresis		%FSO	<0,3
Crosstalk	$F_x \leftrightarrow F_y$	%	< \pm 1,5
	$F_x, F_y \rightarrow F_z$	%	< \pm 2,0
	$F_z \rightarrow F_x, F_y$	%	< \pm 0,5 ¹⁾
Rigidity	x-axis ($a_y = 0$)	N/ μ m	\approx 12
	y-axis ($a_x = 0$)	N/ μ m	\approx 12
	z-axis ($a_x = a_y = 0$)	N/ μ m	\approx 8
Natural frequency	f_n (x, y)	Hz	\approx 350
	f_n (z)	Hz	\approx 200
Operating temperature range		$^{\circ}$ C	0 ... 60
Weight		kg	17,5
Degree of protection	EN 60529:1992		IP50/IP63 ²⁾

Force Plate without Charge Amplifier, Type 9286B

Calibrated range	F_x, F_y	kN	-2,5 ... 2,5
	F_z	kN	0 ... 5
Calibrated partial range	F_x, F_y	kN	0 ... 0,25
	F_z	kN	0 ... 1
Threshold	F_x, F_y, F_z	mN	<10
Sensitivity	F_x, F_y	pC/N	-7,8 ³⁾
	F_z	pC/N	-3,6 ³⁾

¹⁾ inside sensor rectangle

²⁾ Type 9286B with charge output IP63

³⁾ nominal value

Force Plate with Built-in 8 Channel Charge Amplifier, Type 9286BA

Calibrated range 3	F _x , F _y	kN	-2,5 ... 2,5
	F _z	kN	0 ... 10
Calibrated partial range	F _x , F _y	kN	0 ... 0,25
	F _z	kN	0 ... 1
Sensitivity range 1	F _x , F _y	mV/N	≈40 ³⁾
	F _z	mV/N	≈18 ³⁾
Sensitivity range 4	F _x , F _y	mV/N	≈2,0 ³⁾
	F _z	mV/N	≈0,9 ³⁾
Ratio ranges 1:2:3:4			1 : 5 : 10 : 20 ⁴⁾
Threshold		mN	<250 ⁵⁾
Drift		mN/s	<±10
Supply voltage		V DC	10 ... 30
Supply current		mA	≈45

Output voltage	V	0 ... ±5
Output current	mA	-2 ... 2
Control inputs (optocoupler)	V	5 ... 45
	mA	0,4 ... 4,4

- 3) nominal value
- 4) ±0,5 % accuracy
- 5) only range 1

Conforms to the CE safety standards (73/23/EG) for electrical equipment and systems:

EN 60601-1:2005, EN 61010-1:2001 and the EMC standards (89/336/EG): EN 60601-1:2005 (EN 55022 Class B), EN 61000-6-3:2004 (EN 55022 Class B), EN 61000-6-4:2001 (EN 55011 Class B), EN 60601-1:2005, EN 61000-6-1:2001, EN 61000-6-2:2005

Dimensions

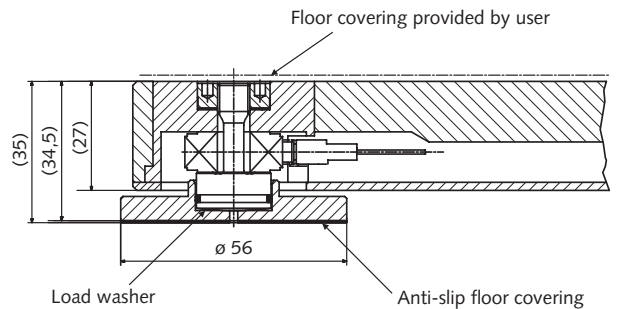
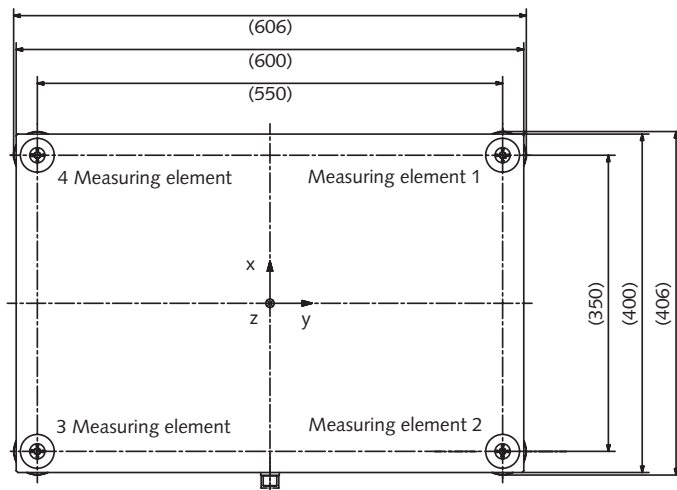
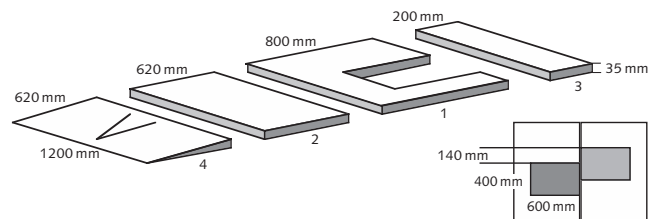

Fig. 1: Dimensions of portable multicomponent force plate Type 9286BA

Walkway Type 9401B...

Four different lightweight sandwich elements are available for assembling a walkway of any length with various arrangements of force plates. An anti-slip floor covering provides safety on the walkway as well as on the force plate.



Walkway:
1 = Type 9401B01, 2 = Type 9401B02, 3 = Type 9401B03,
4 = Type 9401B04

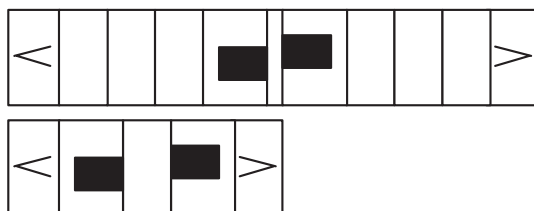

Fig. 2: Mounting examples

9286B_000-713e-02..14

BioWare®

BioWare software is the engine behind the force plate system. It collects data from the force plates, converts the trials into useful information and plots the results. The force plates and charge amplifiers are fully remote controlled by BioWare thus making the system extremely flexible and easy-to-use.

Parameters of Gait

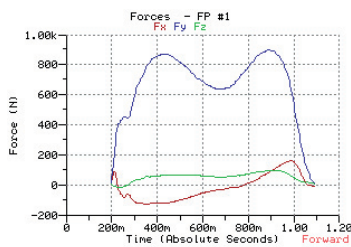

Fig. 3: Ground reaction forces (GRF)

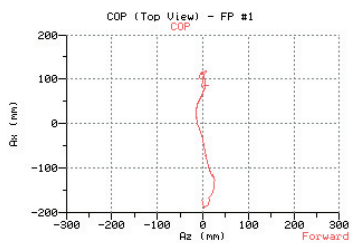

Fig. 4: Center of pressure (COP)

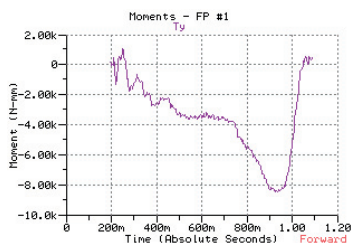

Fig. 5: Frictional torque T_z

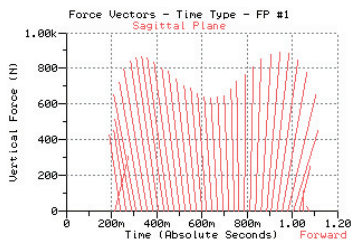

Fig. 6: Force vector

Other functions

- Coefficient of friction (COF)
- Frequency analysis, statistics, digital filters
- Full Windows® functionality

Windows® is a registered trade mark of Microsoft Corporation.

This information corresponds to the current state of knowledge. Kistler reserves the right to make technical changes. Liability for consequential damage resulting from the use of Kistler products is excluded.

BioWare provides several performance specific evaluations.

Parameters of Countermovement Jump CMJ

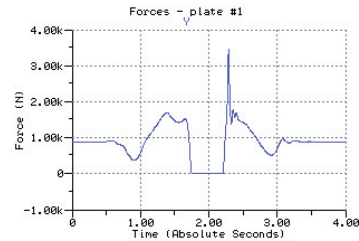

Fig. 7: Jump force

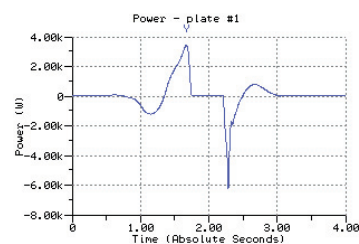

Fig. 8: Power

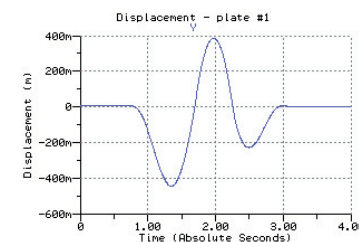

Fig. 9: Jump height (COM)

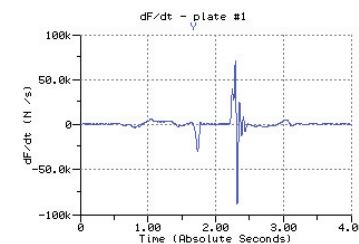

Fig. 10: Force gradient (Explosivity)

Other parameters

- Acceleration, velocity and displacement of the center of mass (COM)
- Work, energy, impulse
- Statistics, digital filters

9286B_000-713e-02.14

Typical Measuring Chains



			
Force plate with built-in charge amplifier Type 9286BA	Connection cable Type 1758A...	DAQ system (USB 2.0) Type 5691A1	Laptop (provided by user) with BioWare

Fig. 11: Configuration of a typical measuring chain with Kistler DAQ system BioWare®

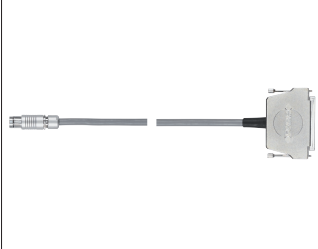

			Ch 1 = F _x 1+2 Ch 5 = F _z 1 Ch 2 = F _x 3+4 Ch 6 = F _z 2 Ch 3 = F _y 1+4 Ch 7 = F _z 3 Ch 4 = F _y 2+3 Ch 8 = F _z 4
Force plate with built-in charge amplifier Type 9286BA	Connection cable Type 1760A...	External Control Unit (8xBNC neg.) Type 5233A2	DAQ system provided by user (8 analog channels)

Fig. 12: Configuration of a typical measuring chain

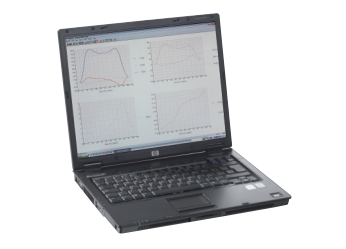
Included Accessories

- 1 shim set
- 1 voltage equalizing cable

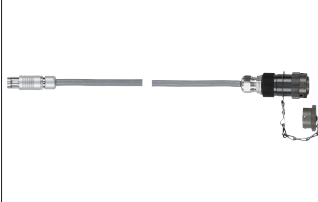
Type/Art. No.

- 7.050.031
- 5.590.175

For Type 9286B with charge output

- External charge amplifier 9865E...
- Connection cable, straight plug 1685B...
- Connection cable, angle plug 1686A...
- DAQ system for BioWare (PCI-Bus) 2812A...

Optional Accessories

For Type 9286BA with built-in charge amplifier

- 16ch DAQ-System for BioWare (USB 2.0) 5691A1
- Connection cable for 5691A, straight plug 1758A...
- Connection cable for 5691A, angle plug 1759A...
- 64ch DAQ-System for BioWare (USB 2.0) 5695B1
- Connection cable for 5695B, straight plug 1700A105B...
- Connection cable for 5695B, angle plug 1700A105A...
- External Control Unit (BNC out) 5233A2
- Connection cable, straight for Type 5233A... 1760A...
- Connection cable, angled for Type 5233A... 1757A...
- DAQ system BioWare (PCI-Bus) 2812A...

Type/Art. No.

For Type 9286B...

- Walkway, central piece 9401C01
- Walkway, extension 9401C02
- Walkway, intermediary piece 9401C03
- Walkway, ramp 9401C04

Ordering Key

Portable Multicomponent Force Plate

with charge output	–
with built-in charge amplifier	A

Type 9286B



9286B_000-713e-02..14

BioWare® is a registered trade mark of Kistler Holding AG.